

INSTALLATION INSTRUCTIONS

Standard Copper Ground Kits

©2024

1886 IB A

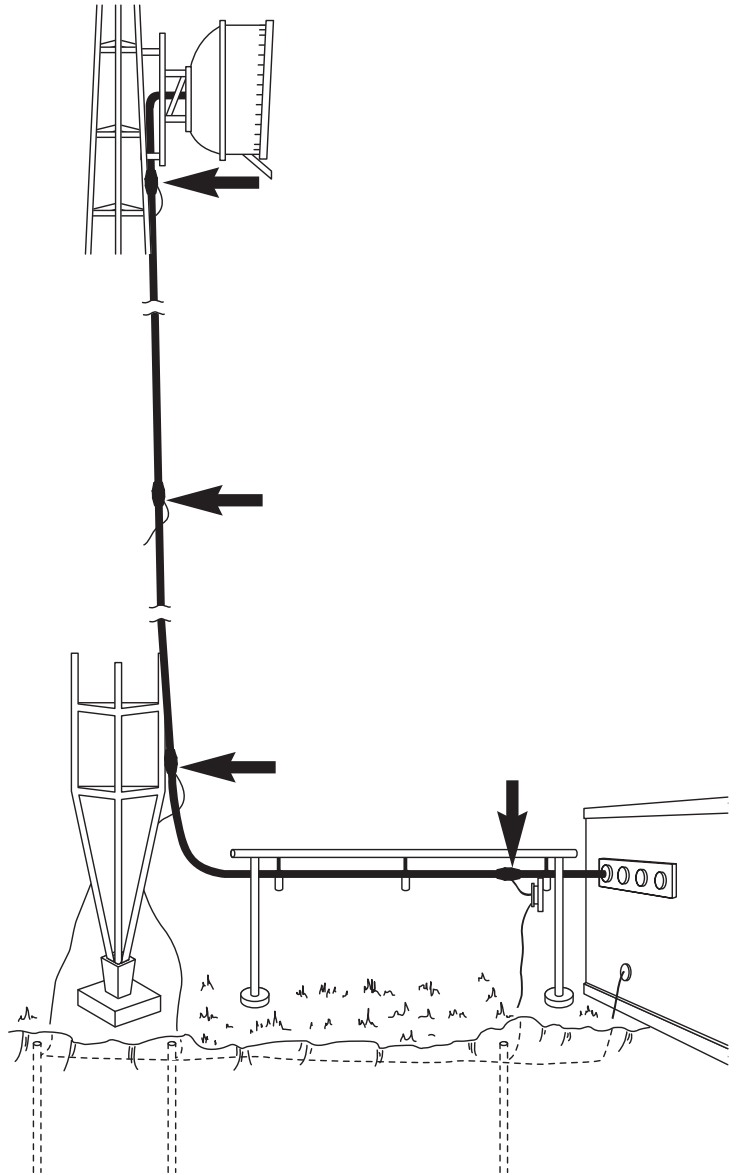
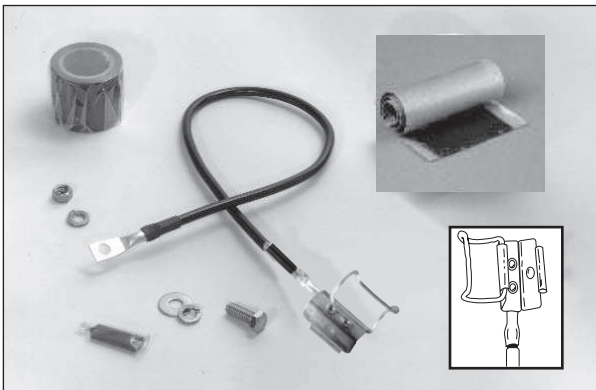
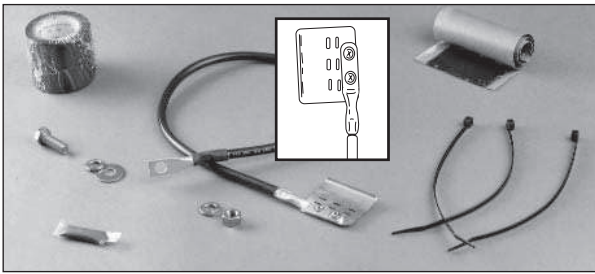
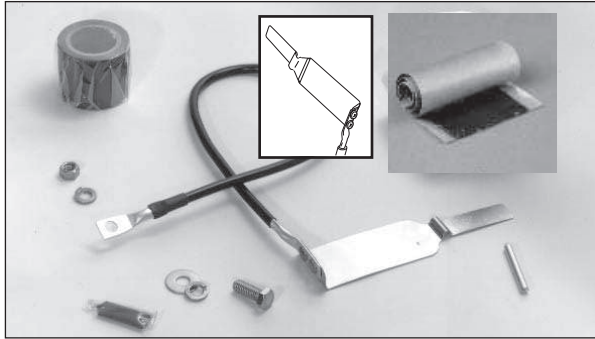



WARNING

Do not attempt grounding kit installation in the presence of thunderstorms. Failure to obey this warning may result in injury or death to you or to others.

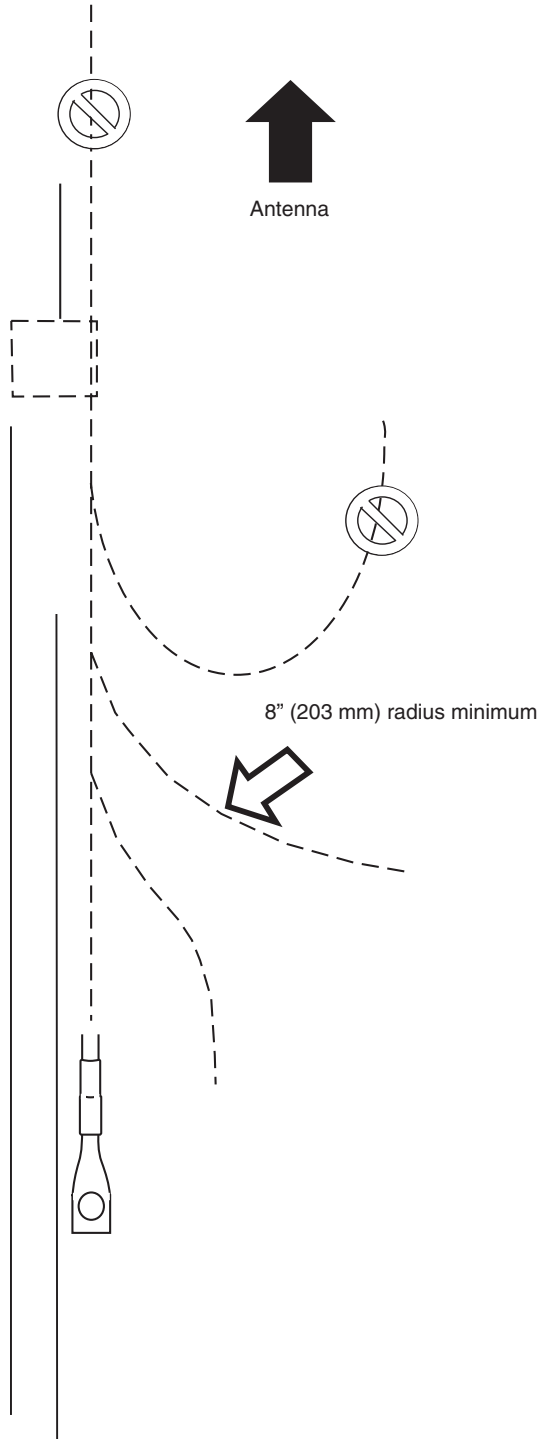
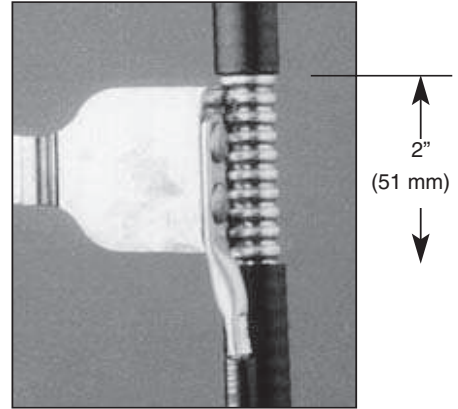
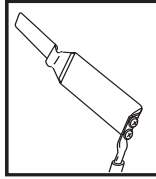

Antenna

8" (203 mm) radius minimum

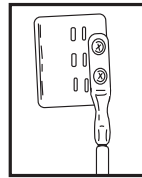

FSJ1 LDF2, EW240

2.5"
(63 mm)

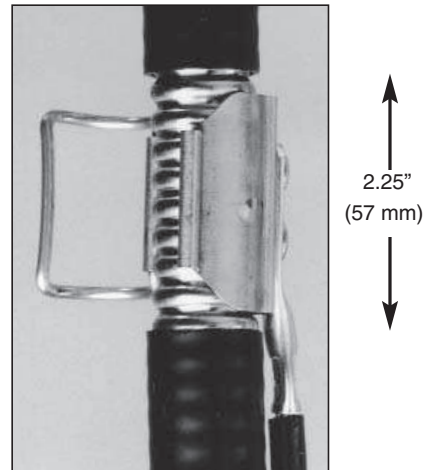
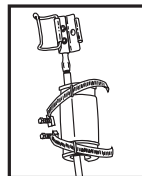
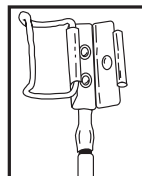

2.25"
(57 mm)

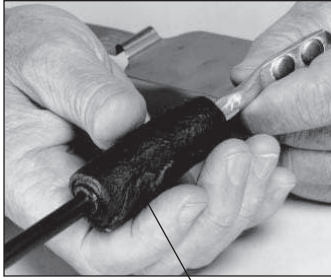
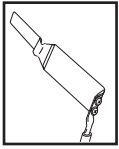

1-1/2" x 2-1/2"
(38 x 63.5 mm)

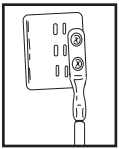
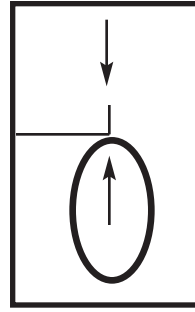

1-1/2" x 2-1/2"
(38 x 63.5 mm)

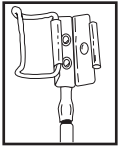
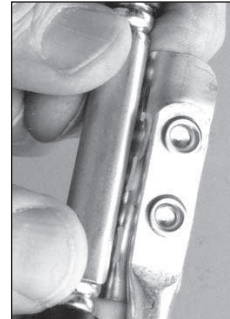
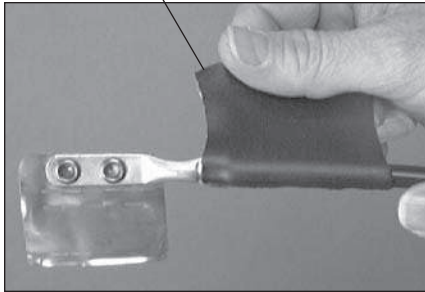

1-1/2" x 2-1/2"
(38 x 63.5 mm)

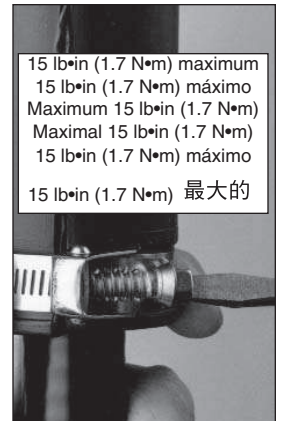
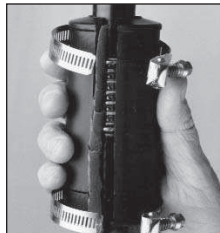
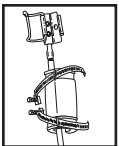
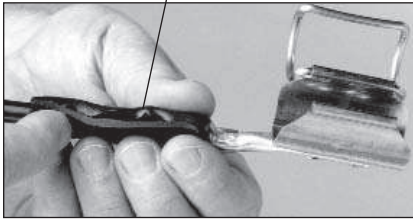

15 lb•in (1.7 N•m) maximum
15 lb•in (1.7 N•m) máximo
Maximum 15 lb•in (1.7 N•m)
Maximal 15 lb•in (1.7 N•m)
15 lb•in (1.7 N•m) máximo
15 lb•in (1.7 N•m) 最大的

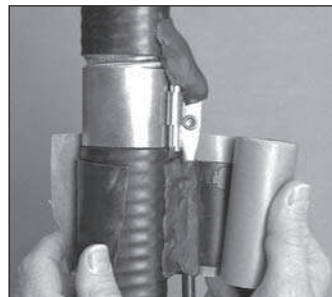
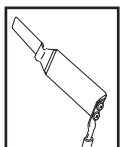
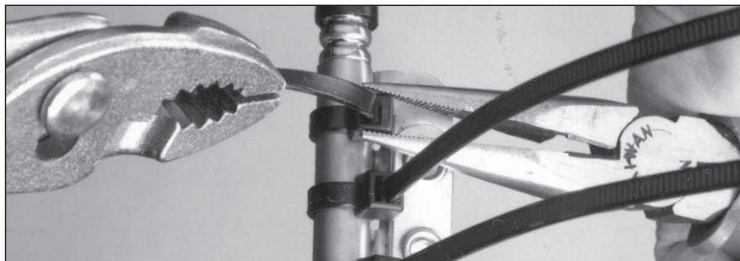
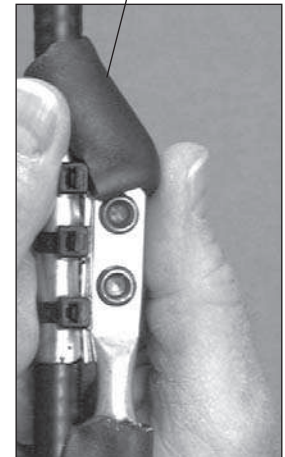
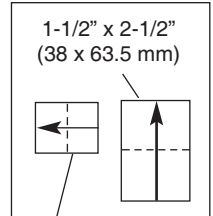
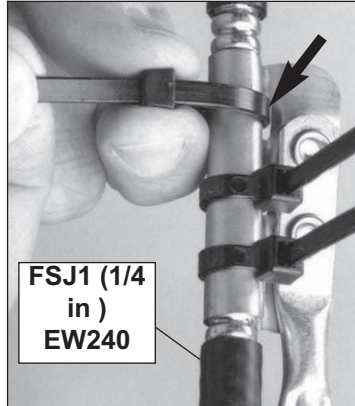
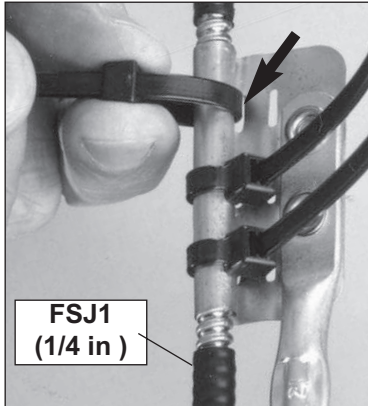
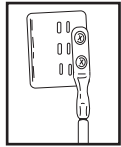
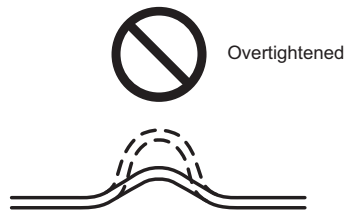
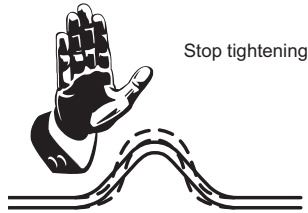
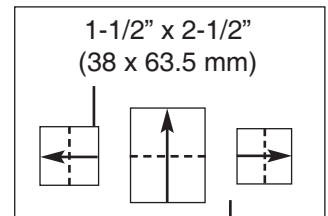
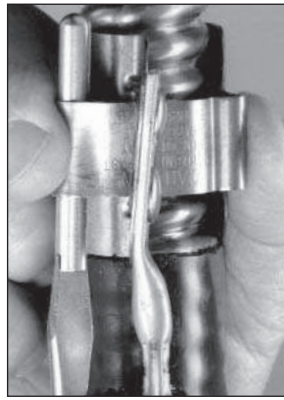
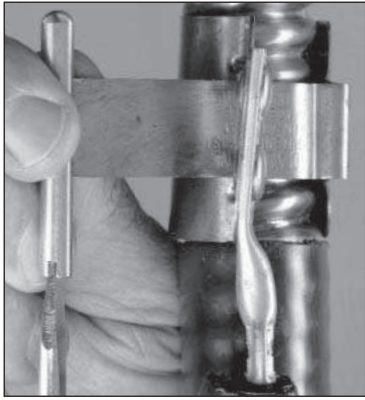
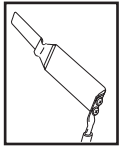

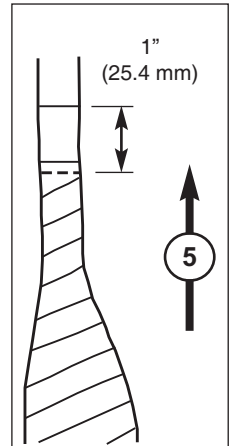
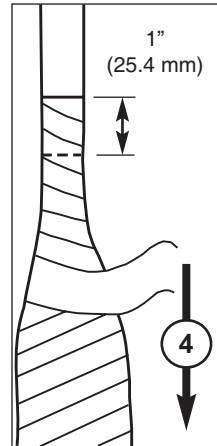
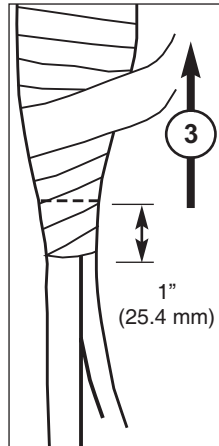
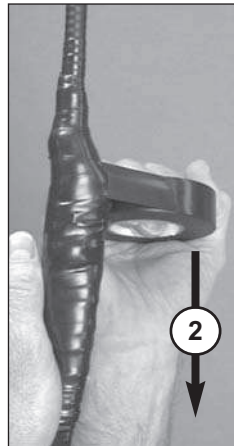
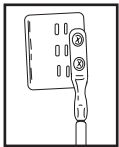
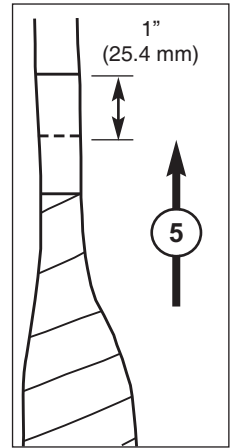
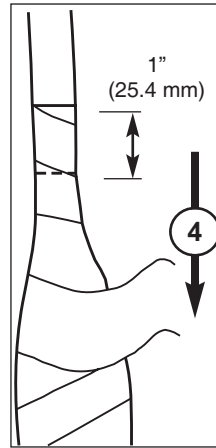
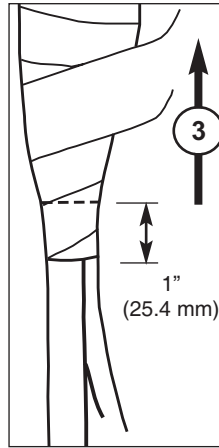
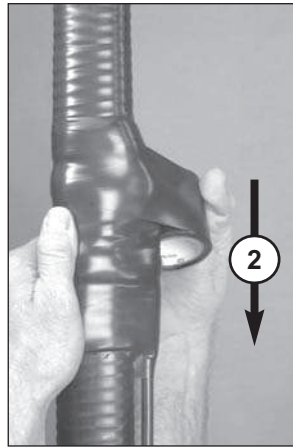
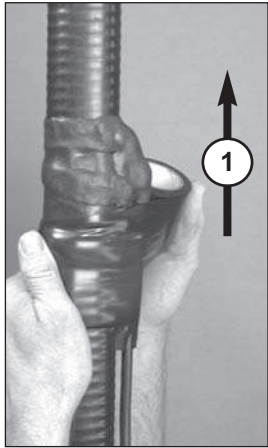
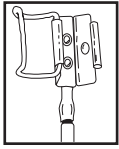

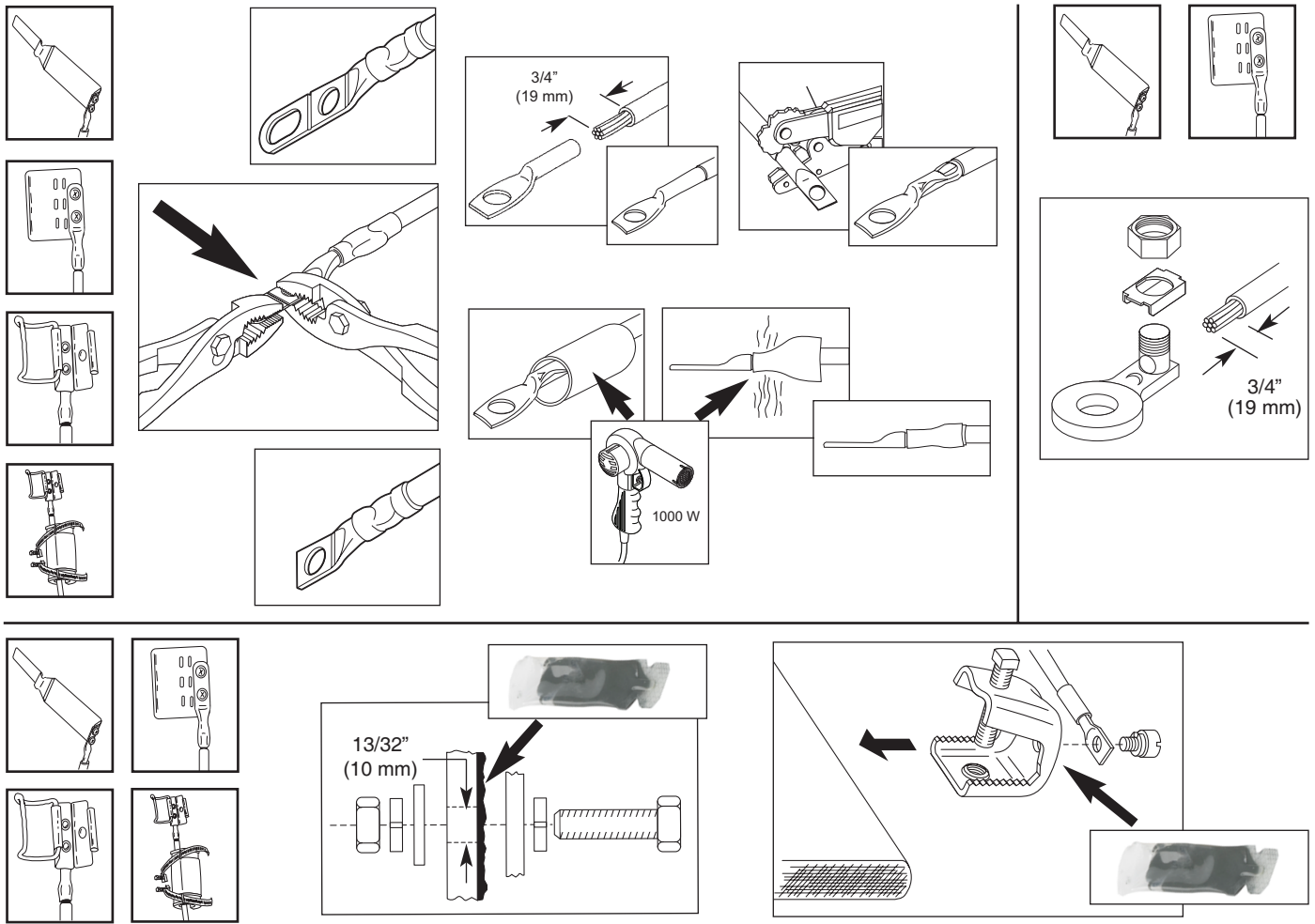

Notice

The installation, maintenance, or removal of antenna systems requires qualified, experienced personnel. Installation instructions are written for such personnel. Antenna systems should be inspected once a year by qualified personnel to verify proper installation, maintenance, and condition of equipment.

Manufacturer disclaims any liability or responsibility for the results of improper or unsafe installation practices.